

Powered by



UPS123606 ▶

UPS 123606 is specially designed for high efficient discharge application. Its characteristics are high energy density, small footprint and high discharge efficiency. It can be used for more than 260 cycles at 100% discharge in cycle service, up to 5 years in standby service.



► Specification

Cells Per Unit	6
Voltage Per Unit	12
	360W @ 5min-rate to Watt(1.60V)/pcs @25°C (77°F)
Capacity	
Weight	Approx. 1.97 kg(4.34 lbs)
Maximum Discharge Current	100/130A(5sec)
Internal Resistance	Approx. 22mΩ
Operating Temperature Range	Discharge: -15°C~50°C (5°F~122°F) Charge: -15°C~40°C (5°F~104°F) Storage: -15°C~40°C (5°F~104°F)
Nominal Operating Temperature Range	25°C±3°C (77°F±5°F)
Float Charging Voltage	13.5 to 13.8 VDC/unit Average at 25°C (77°F)
Recommended Maximum Charging Current Limit	3.0A
Equalization and Cycle Service	14.4 to 15.0 VDC/unit Average at 25°C (77°F)
Self Discharge	CSB Batteries can be stored for more than 6 months at 25°C (77°F). Please charge batteries before using. For higher temperatures the time interval will be shorter.
Terminal	F1/F2-Faston Tab 180/250
Container Material	ABS(UL 94-HB) & Flammability resistance of (UL 94-V0) can be available upon request.



MH14533(N)



No.:041005117



CSB-manufactured VRLA batteries are UL-recognized components under UL924 and UL1989.

CSB is also certified by ISO 9001 and ISO 14001.

► Dimensions : Unit: mm (inch)	Overall Height (H)	Container height (h)	Length (L)	Width (W)
	98.3±1.0 (3.87±0.04)	94.0±1.0 (3.70±0.04)	151.0±2.0 (5.94±0.08)	51.0±1.0 (2.01±0.04)

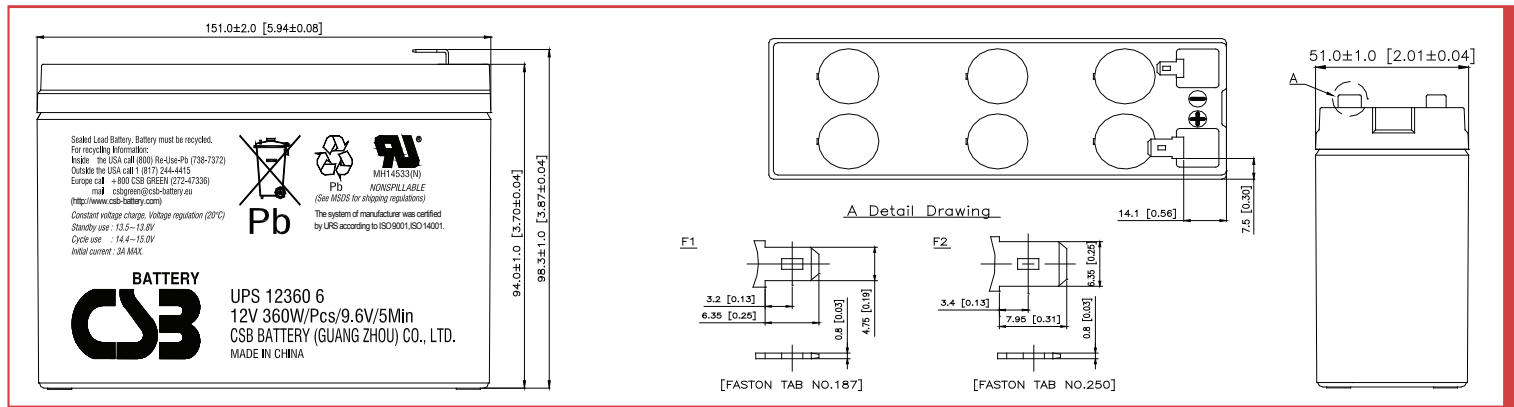

Constant Current Discharge Characteristics Unit:A (25°C,77°F)

F.V/Time	2MIN	3MIN	4MIN	5MIN	6MIN	7MIN	8MIN	10MIN	15MIN	20MIN	30MIN	60MIN	90MIN
1.60V	61.7	49.0	41.2	35.3	31.1	27.7	24.7	20.7	15.2	12.1	8.90	5.10	3.64
1.67V	55.0	45.7	38.8	33.7	30.1	26.7	24.0	20.4	15.1	12.1	8.84	5.06	3.62
1.70V	52.2	43.8	37.5	32.6	29.2	26.0	23.6	20.1	15.0	12.0	8.81	5.02	3.61
1.75V	47.1	40.0	34.6	30.8	27.2	24.6	22.5	19.2	14.6	11.8	8.68	4.97	3.58
1.80V	42.4	36.0	31.4	27.6	24.8	22.4	20.7	18.0	13.9	11.3	8.40	4.88	3.52
1.85V	36.8	31.3	27.0	24.1	21.7	20.1	18.5	16.4	12.7	10.5	7.95	4.63	3.38

Constant Power Discharge Characteristics Unit:W (25°C,77°F)

F.V/Time	2MIN	3MIN	4MIN	5MIN	6MIN	7MIN	8MIN	10MIN	15MIN	20MIN	30MIN	60MIN	90MIN
1.60V	558	467	403	360	318	284	259	222	169	135	100.0	58.4	42.4
1.67V	529	444	388	347	308	277	254	218	167	134	99.1	58.0	42.3
1.70V	510	436	381	340	301	272	250	216	165	133	98.7	57.7	42.0
1.75V	472	408	364	319	287	261	238	210	159	132	98.2	57.3	41.7
1.80V	423	376	330	293	264	244	225	199	154	126	96.0	56.4	41.2
1.85V	374	324	287	261	238	220	204	183	142	119	91.7	54.6	40.2

Ratings presented herein are subject to revision without notice. Please refer to www.csb-battery.com to confirm the latest version.

Trickle (or Float) Service Life

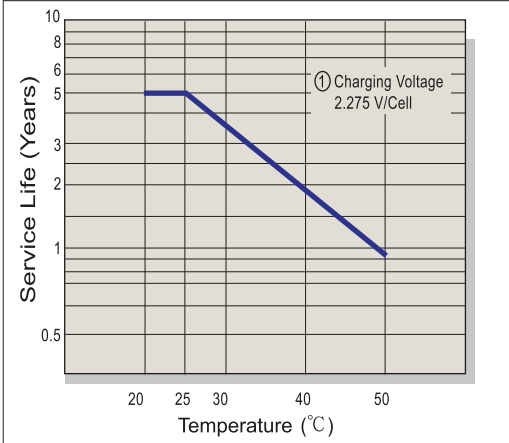

Capacity Retention Characteristic

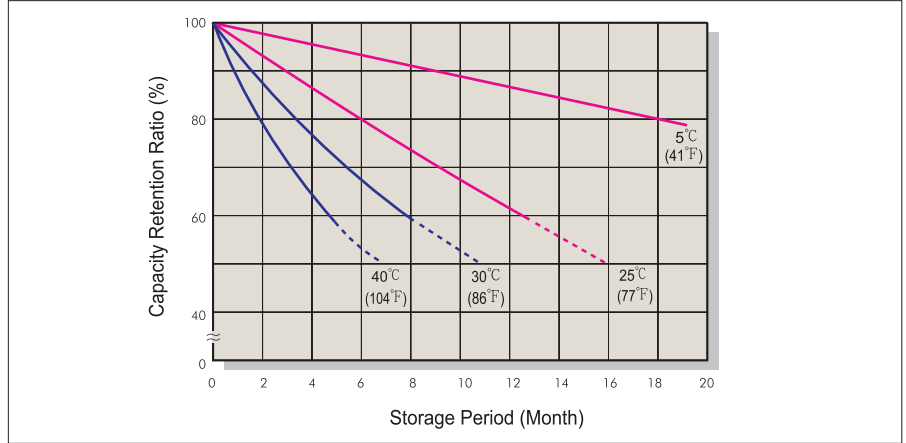

Battery Voltage and Charge Time for Standby Use

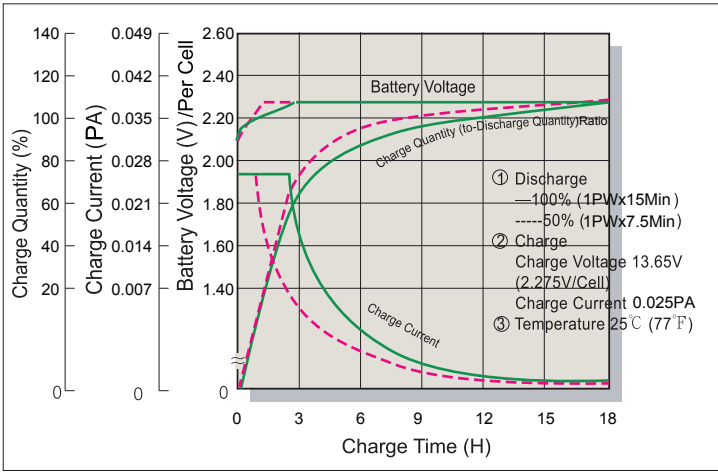

Cycle Service Life

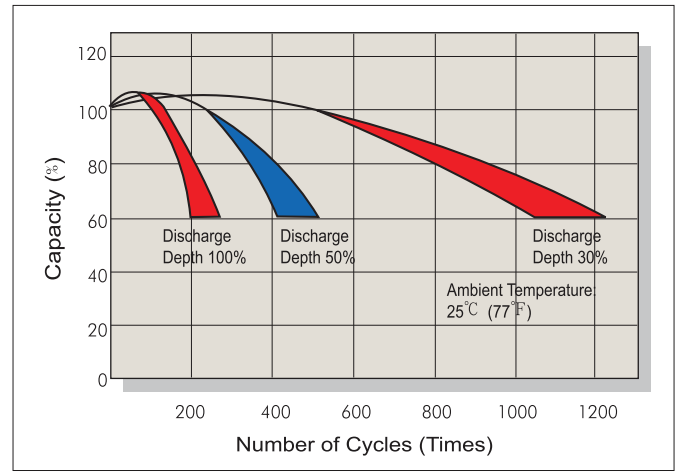

Battery Voltage and Charge Time for Cycle Use

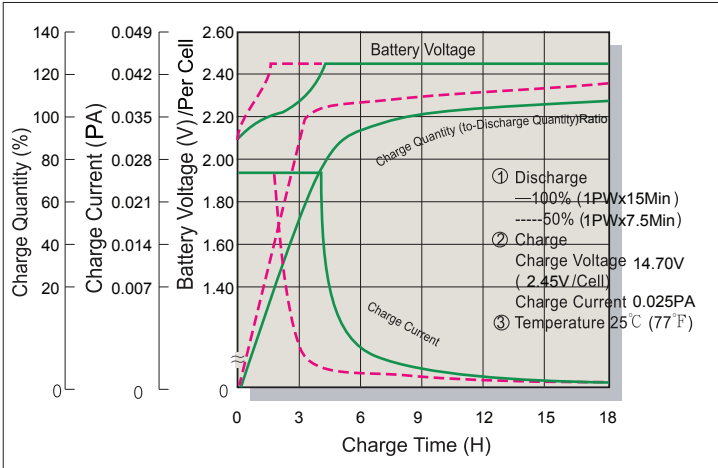

Terminal Voltage (V) and Discharge Time

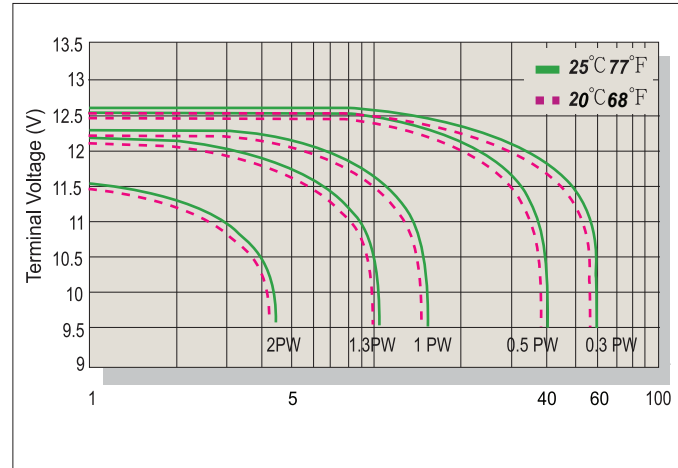

Charging Procedures

Application	Charge Voltage(V/Cell)			Max.Charge Current
	Temperature	Set Point	Allowable Range	
Cycle Use	25°C(77°F)	2.45	2.40~2.50	0.1PA
Standby	25°C(77°F)	2.275	2.25~2.30	

P: For single cell wattage at 15 minute rate to 1.67V per cell.

Discharge Current VS. Discharge Voltage

Final Discharge Voltage V/Cell	1.75	1.70	1.60	1.30
Discharge Power(W)	0.1P>(W)	0.1P≤(W)<0.25P	0.25P≤(W)<1.0P	(W)≥1.0P

Sales Office URL:WWW.CSB-BATTERY.COM

GLOBAL HQ
CSB BATTERY CO., LTD. (TAIWAN)
 Tel : +886-2-2880-5600
 Fax : +886-2-2888-3300
 mail : service@csb-battery.com.tw

BEIJING OFFICE. (CHINA)
CSB BATTERY TECHNOLOGIES (BEIJING) CO., LTD.
 Tel : +86-10-5820-5336/5338
 Fax : +86-10--58203053
 mail : chinasl@csb-battery.com

AMERICA HQ
CSB BATTERY TECHNOLOGIES INC. (U.S.A)
 Tel : +1-817-244-7777/1-(800)3-CSB-USA(272872)
 Fax : +1-817-244-4445
 mail : csb@csb-battery.com

SHANGHAI OFFICE. (CHINA)
CSB BATTERY LOGISTIC (SHANGHAI) CO., LTD.
 Tel : +86-21-5046-1622/5046-0833
 Fax : +86-21-5064-1046
 mail : chinasl@csb-battery.com

EUROPE HQ
CSB Battery Europe BV.
 Tel : +31(0)-180-418-140
 Fax : +31(0)-180-418-327
 mail : eurosales@csb-battery.eu

SHENZHEN OFFICE.(CHINA)
CSB BATTERY LOGISTIC (SHANGHAI) CO., LTD.
 Tel : +86-755-8831-6488/6396/6356
 Fax : +86-755-8831-6548
 mail : she@csb-battery.com.cn