

Powered by



EVX 12750 ▶ 12V 75Ah

EVX 12750 is designed specially for electric vehicles, such as electric golf cart, electric wheelchair, mower, dust collector...etc. It has high cycling life, high efficiency and long service life.



► Specification

Cells Per Unit	6
Voltage Per Unit	12
Capacity	75Ah @ 20hr-rate to 1.75V per cell @25 °C (77°F)
Weight	Approx. 25.6 kg (56.44 lbs)
Maximum Discharge Current	500A(5sec)
Internal Resistance	Approx. 4.5 mΩ
Operating Temperature Range	Discharge: -15°C~50°C (5°F~122°F) Charge: -15 °C~40°C (5°F~104°F) Storage: -15°C~40°C (5°F~104°F)
Nominal Operating Temperature Range	25°C±3°C(77°F±5°F)
Float Charging Voltage	13.5 to 13.8 VDC/unit Average at 25°C(77°F)
Recommended Maximum Charging Current Limit	22.5 A
Equalization and Cycle Service	14.4 to 15.0 VDC/unit Average at 25°C(77°F)
Self Discharge	CSB Batteries can be stored for more than 6 months at 25°C(77°F). Please charge batteries before using. For higher temperatures the time interval will be shorter.
Terminal	B6-L terminal to accept 5/16" nut & bolt
Container Material	Polypropylene(UL 94-V0) & Flammability resistance of (UL 94-HB) can be available upon request.



MH14533(N)



No.:041005117



ISO 14001
NO.UM 1-12-0045

CSB-manufactured VRLA batteries are UL-recognized components under UL924 and UL1989.

CSB is also certified by ISO 9001 and ISO 14001.

► Dimensions :	Overall Height (H)	Container height (h)	Length (L)	Width (W)
	Unit: mm (inch)	233.2±2.5 (9.18±0.1)	211.2±2.5 (8.31±0.1)	275±2.5 (10.83±0.1)

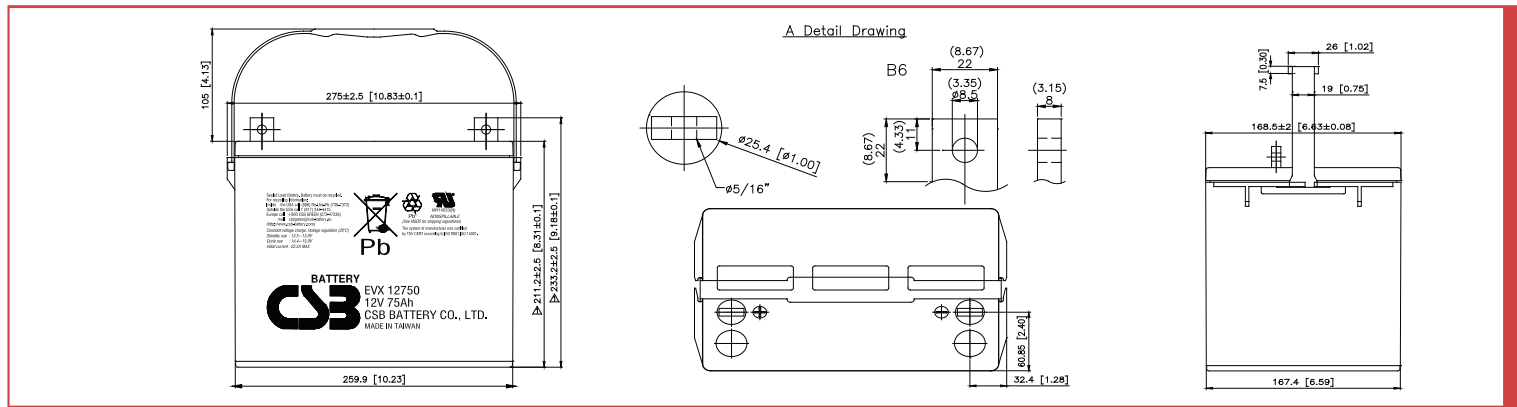

Constant Current Discharge Characteristics Unit:A (25°C, 77°F)

F.V./Time	30MIN	60MIN	90MIN	2HR	3HR	4HR	5HR	8HR	10HR	20HR
1.60V	83.2	49.3	35.7	28.1	19.9	15.6	12.8	8.35	6.82	3.84
1.67V	81.6	48.6	35.2	27.6	19.7	15.4	12.7	8.25	6.74	3.80
1.70V	80.1	47.8	34.6	27.2	19.4	15.2	12.5	8.15	6.67	3.77
1.75V	78.1	46.8	33.9	26.7	19.2	15.0	12.4	8.07	6.60	3.75
1.80V	75.8	45.7	33.2	26.2	18.9	14.8	12.2	7.98	6.54	3.72
1.85V	73.3	44.4	32.5	25.7	18.6	14.6	12.0	7.89	6.47	3.68

Constant Power Discharge Characteristics Unit:W (25°C, 77°F)

F.V./Time	30MIN	60MIN	90MIN	2HR	3HR	4HR	5HR	8HR	10HR	20HR
1.60V	924	538	392	313	226	177	146	95.2	77.5	41.4
1.67V	906	532	386	309	223	175	144	94.3	77.0	41.2
1.70V	887	524	380	304	219	172	142	93.4	76.4	41.0
1.75V	863	513	373	299	216	170	140	92.3	75.7	40.7
1.80V	839	500	367	293	213	168	139	91.3	75.0	40.6
1.85V	813	484	359	288	210	165	137	90.3	74.2	39.8

Ratings presented herein are subject to revision without notice. Please refer to www.csb-battery.com to confirm the latest version.

Trickle (or Float) Service Life

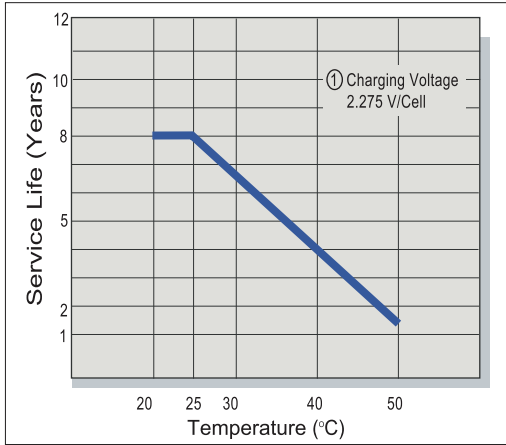

Capacity Retention Characteristic

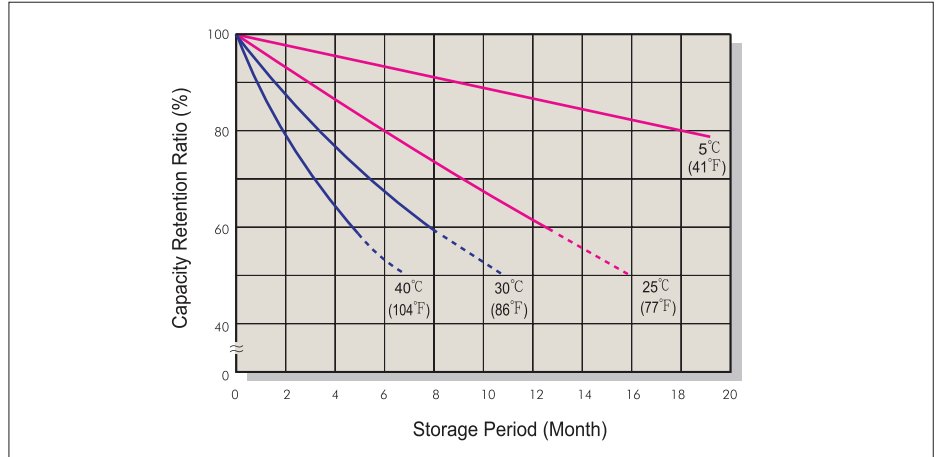

Battery Voltage and Charge Time for Standby Use

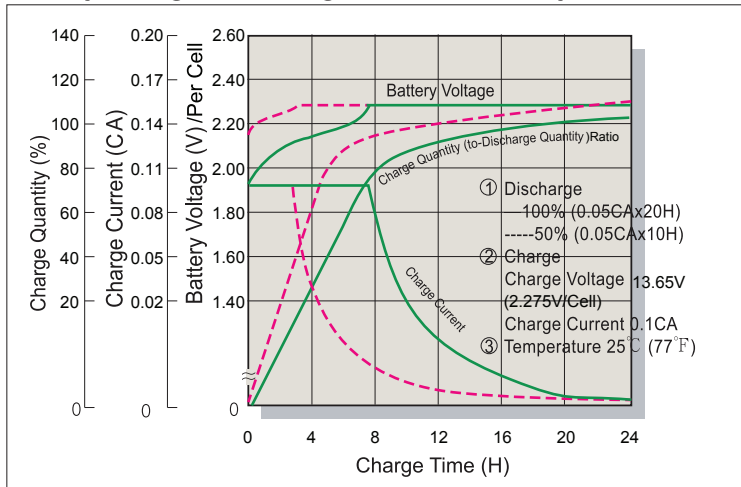

Series Cycle Service Life

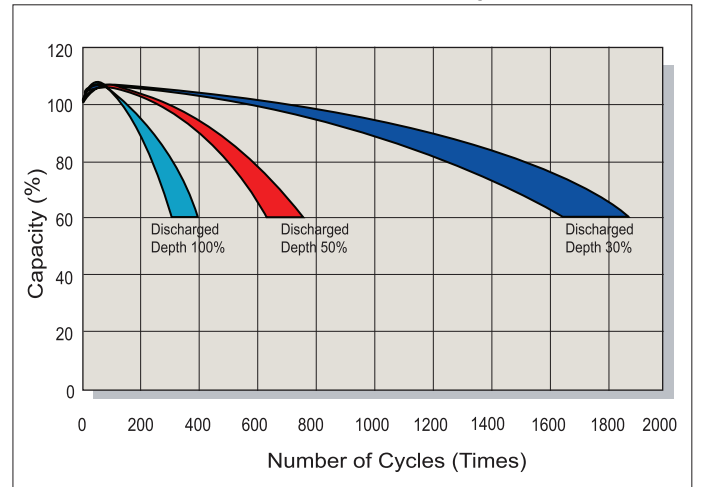

Battery Voltage and Charge Time for Cycle Use

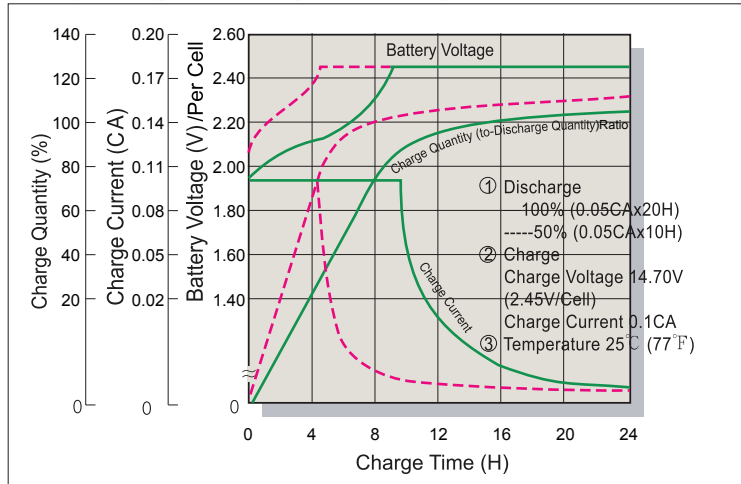

Terminal Voltage (V) and Discharge Time

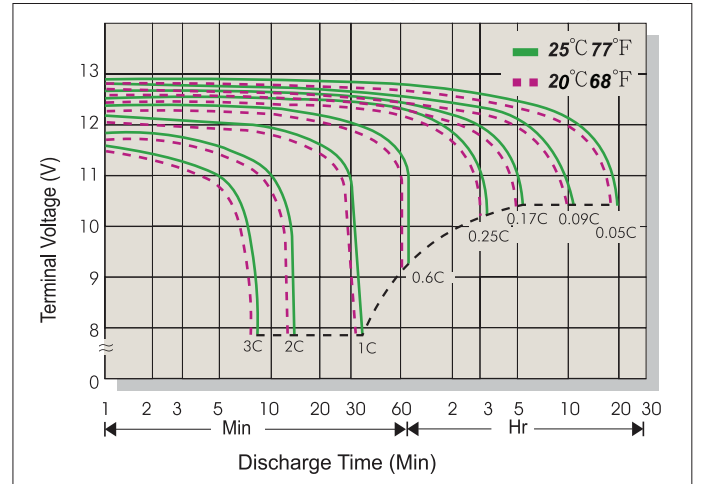

Charging Procedures

Application	Charge Voltage(V/Cell)			Max.Charge Current
	Temperature	Set Point	Allowable Range	
Cycle Use	25°C(77°F)	2.45	2.40~2.50	0.3C
Standby	25°C(77°F)	2.275	2.25~2.30	

Discharge Current VS. Discharge Voltage

Final Discharge Voltage V/Cell	1.75	1.70	1.60	1.30
Discharge Current(A)	0.2C>(A)	0.2C<(A)<0.5C	0.5C<(A)<1.0C	(A)>1.0C

Sales Office URL: WWW.CSB-BATTERY.COM

GLOBAL HQ
CSB BATTERY CO., LTD. (TAIWAN)
 Tel : +886-2-2880-5600
 Fax : +886-2-2888-3300
 mail : service@csb-battery.com.tw

BEIJING OFFICE. (CHINA)
CSB BATTERY TECHNOLOGIES (BEIJING) CO., LTD.
 Tel : +86-10-5820-5336/5338
 Fax : +86-10-58203053
 mail : chinasl@csb-battery.com

AMERICA HQ
CSB BATTERY TECHNOLOGIES INC. (U.S.A)
 Tel : +1-817-244-7777/1-(800)3-CSB-USA(272872)
 Fax : +1-817-244-4445
 mail : csb@csb-battery.com

SHANGHAI OFFICE. (CHINA)
CSB BATTERY LOGISTIC (SHANGHAI) CO., LTD.
 Tel : +86-21-5046-1622/5046-0833
 Fax : +86-21-5064-1046
 mail : chinasl@csb-battery.com

EUROPE HQ
CSB Battery Europe BV.
 Tel : +31(0)-180-418-140
 Fax : +31(0)-180-418-327
 mail : eurosales@csb-battery.eu

SHENZHEN OFFICE. (CHINA)
CSB BATTERY LOGISTIC (SHANGHAI) CO., LTD.
 Tel : +86-755-8831-6488/6396/6356
 Fax : +86-755-8831-6548
 mail : she@csb-battery.com.cn